

**COMPETENCE IN MOVEMENT**

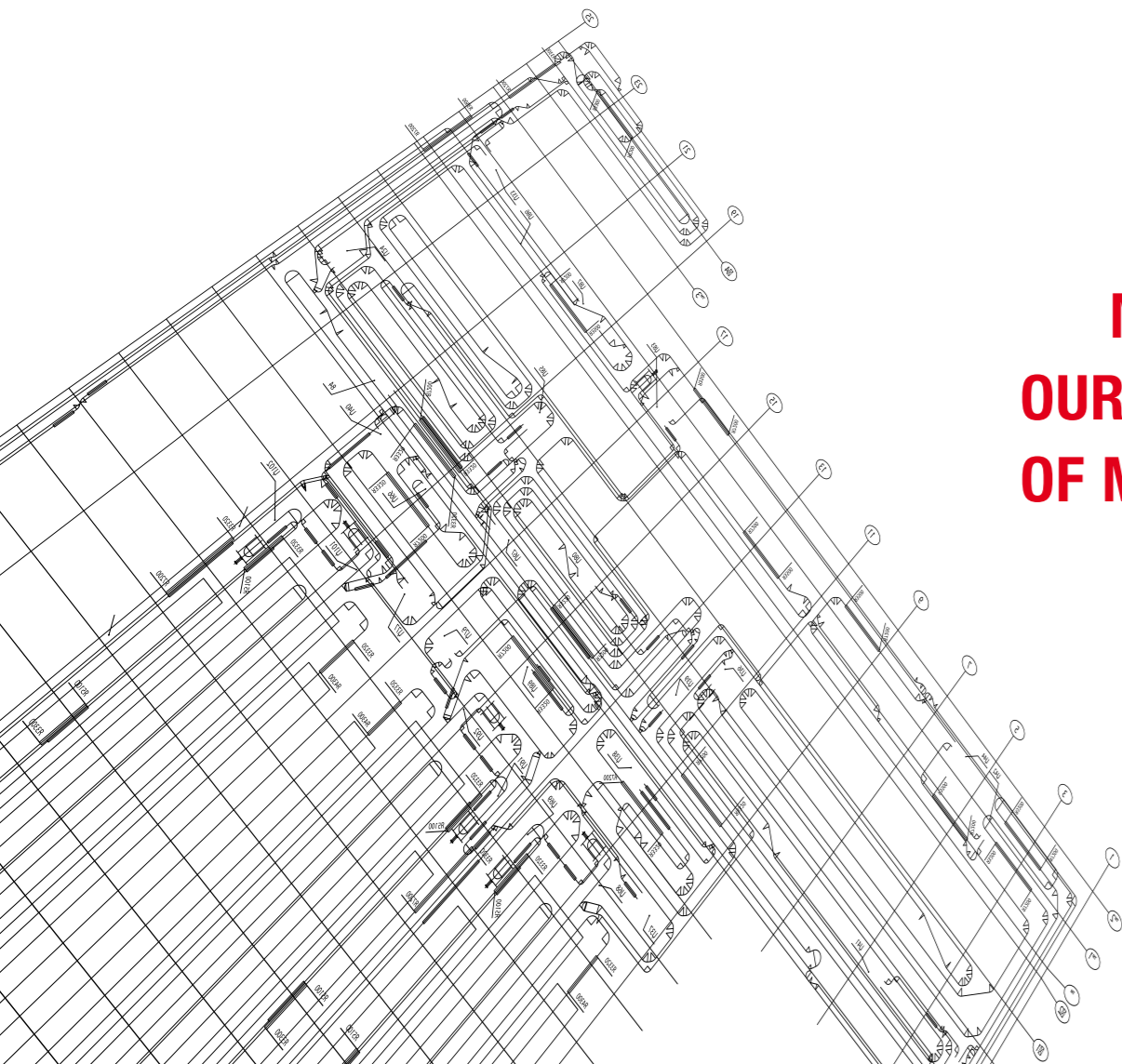

**MIAS.**  
**OUR QUALITY IS THE SUM**  
**OF MANY STRENGTHS.**

At the root of each entrepreneurial success are processes that are as fast as they are precise. Exactly here lie the strengths of MIAS: we ensure perfect intralogistic processes with creative solutions for handling and transport in all five axes. So that everything is exactly there where it is needed and always at the right time. We fulfill this claim through our core competences: comprehensive consultation, individual planning and structuring and premium product quality. Our first class, worldwide service completes your reasons for choosing MIAS. **Just ask us.**

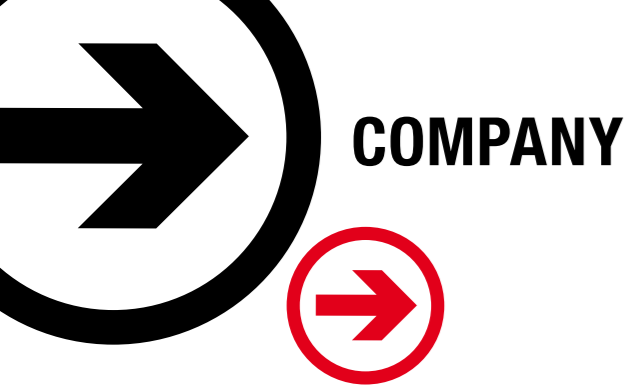

**Wolfgang Büttner**  
chief executive officer



**Dr. Johannes Fottner**  
chief executive officer

**PROJECT PLANNING**  
**DEVELOPMENT**  
**DESIGN**  
**MANUFACTURING**  
**INSTALLATION**  
**SERVICE**

## THE ROAD TO SUCCESS IS PAVED WITH GOOD CONNECTIONS.

MIAS moves and connects. Our **transportation devices** and **load handling attachments** carry loads horizontally and vertically and rotate them at any given point. MIAS systems transport, lift and lower, load and unload all sorts of goods and loads. Precise analysis and planning ensure that each solution meets all the demands of modern production shops, distribution centers and high-bay warehouses. With its **Retrofit Service** MIAS is also a leading address in the world for the modernization of existing systems - of any manufacturer.

**We connect continents.**

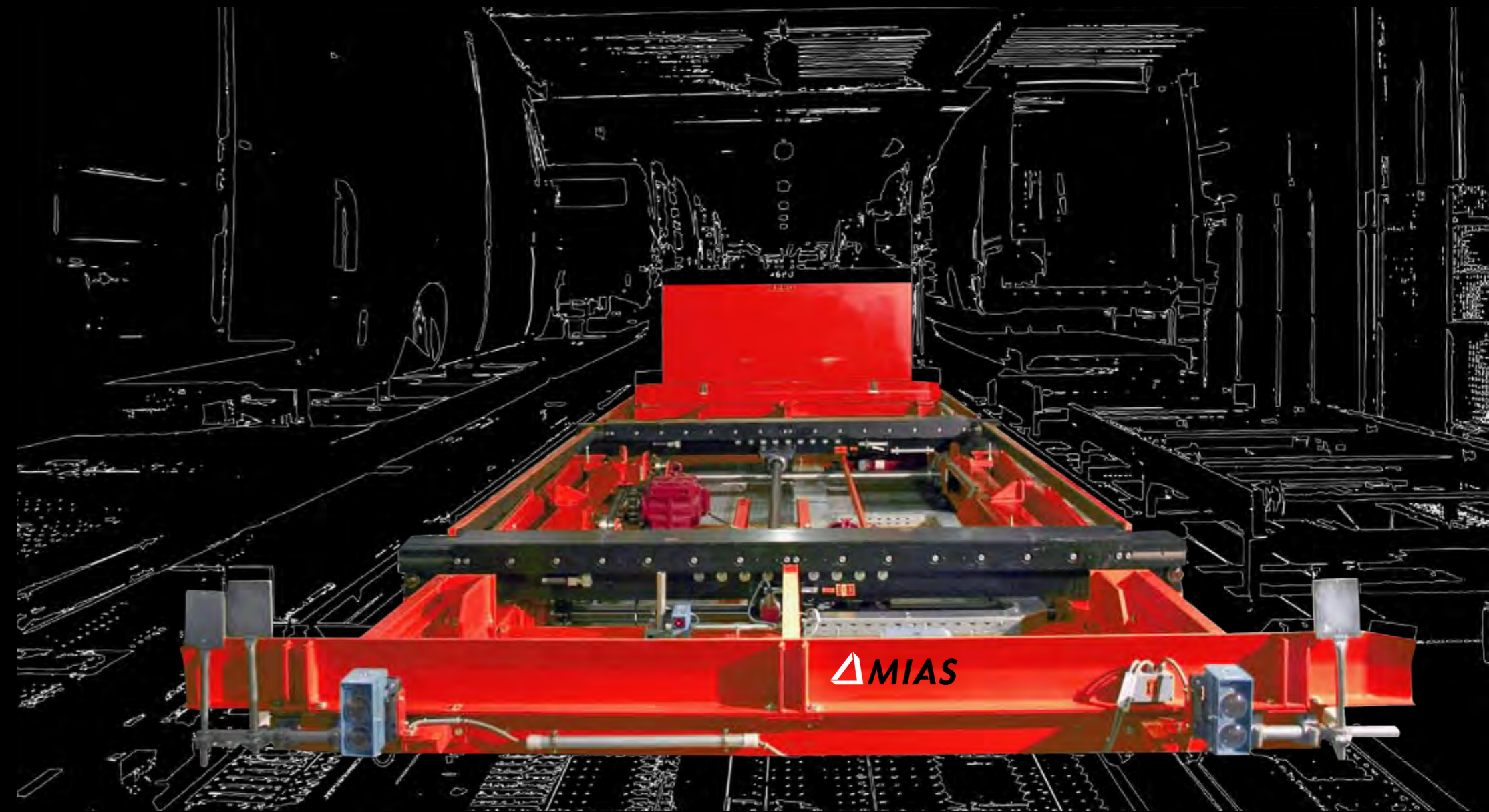
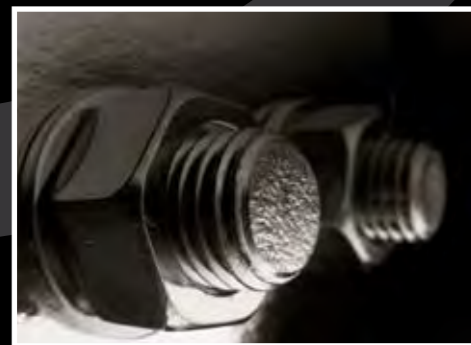

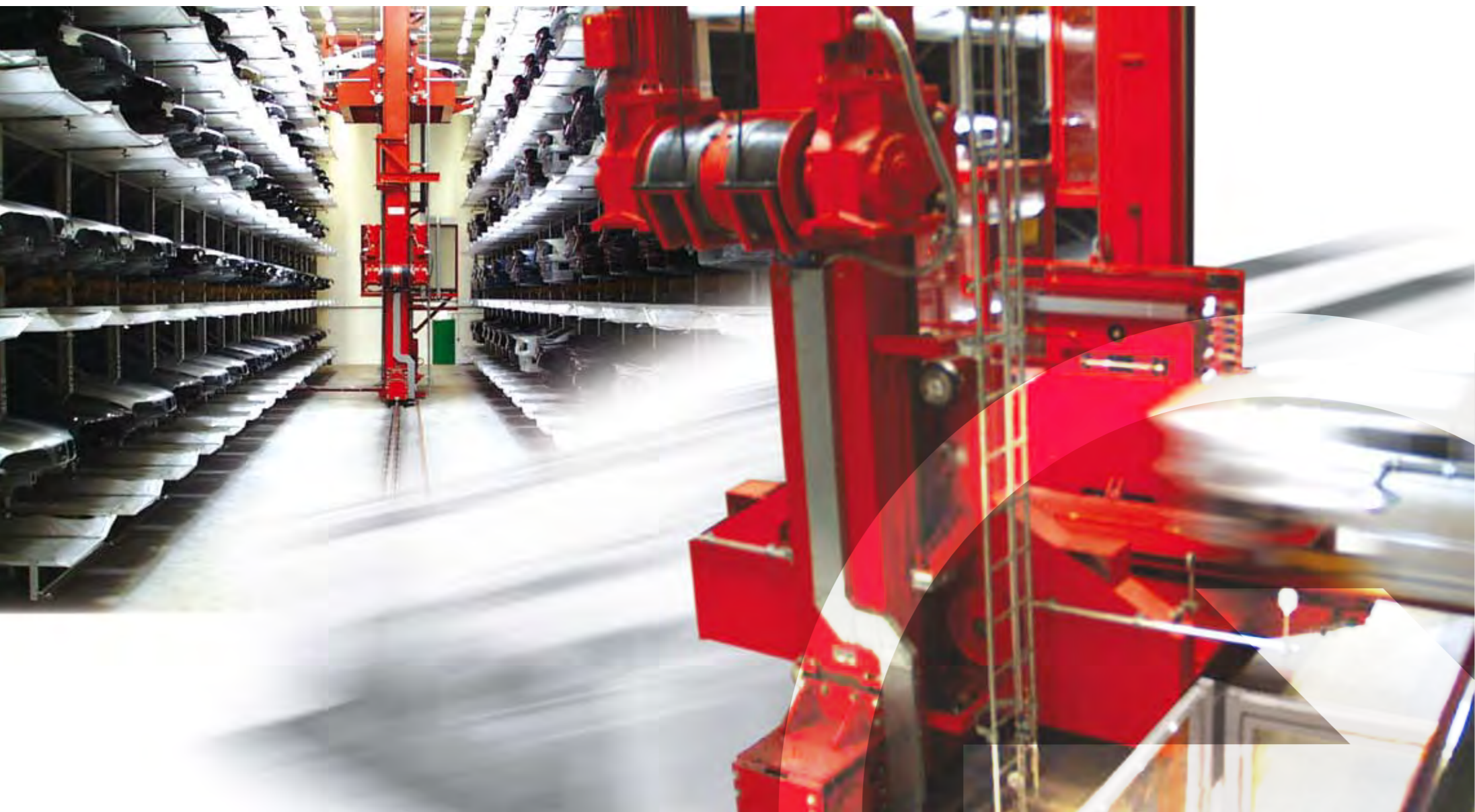

**ALLOW US TO THINK FOR YOU.  
AS IN SOLUTIONS.**

Intensive consultation ensures the fundamental fulfillment of each of your demands. If our solutions are part of a larger project, our experts are also eager to be involved in the overall planning. We manufacture practically all the components of our products ourselves. Thanks to our locations around the world, production and pre-assembly are carried out on site as far as possible. This means both short delivery times and a greater scope to meet customer wishes to an optimum. Our round-the-clock service is always there for you, close at hand.

**The MIAS solution – universally available.**

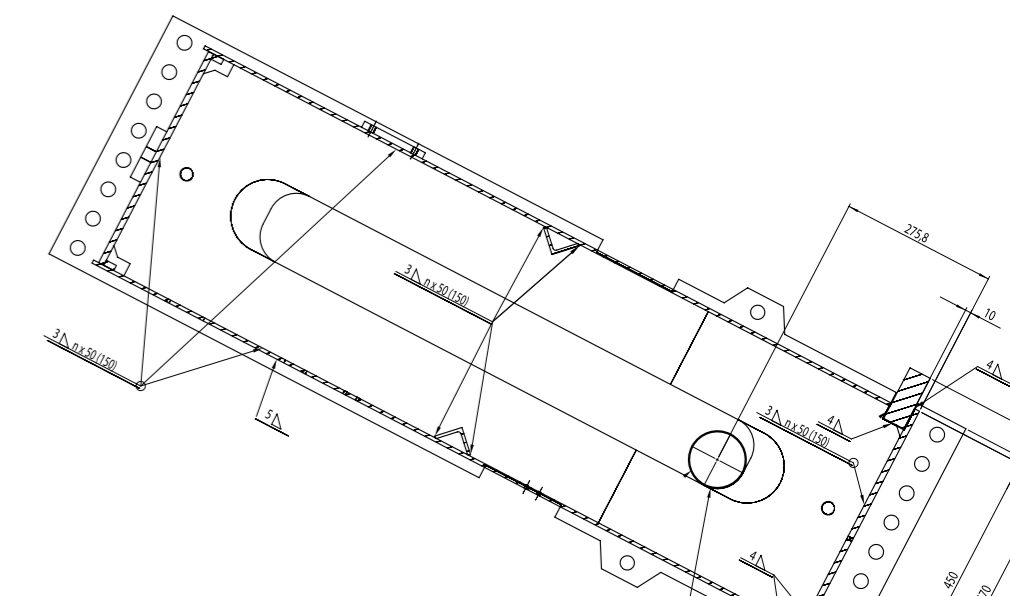



## MIAS. AND EVERYTHING IS IN FLOW.



It does not take long to name the major components of our success: highly skilled employees, continuous training in development and production, leading-edge plant and equipment. Of course we attach great importance to expertly trained service personnel. Almost all the staff and engineers in Customer Service have been with the company for many years. The seamless interaction between our experts in the different departments is also a positive driving force. We thus achieve a constant level of first class quality from consultation and development to commissioning and service. We reliably stand to our claim at all times. **Competence in movement.**



A. Klinkhammer, ABB, Aberle, ABN Engineering, Actiw Oy, Adam Opel, Advanced Nuclear Fuels, AFT, Airbus, ALD, Alko, Alno, Alstef, AMHS, Andritz, Arcelor, AstraZeneca, ATC, Atlas Copco, ATU, Audi, Aurora Muehle, Automha, Axorys, Ballotti, Baust, Baxter, Bayer AG, BDI, Bettenwelt, Beumer, Bewital, Binder, Bleichert, BLG, Blume-Rollen, BMW, Boellhoff, Bosch Rexroth, Bossard, Bruckmann, Brueckner, BSH Bosch Siemens, Buerener, Cargill, Chrysler, Cinetic, Claas, CocaCola, Comau do Brasil, Continental, Corus, Crown, CSI, CTI, CVS, CWS, DAF, Daifuku, Daimler, Decoma, Demag, Dematek, Dematic, Depalo, Deutsche Benkert, DHL, Dimos, Dongil Fatec, Dornieden, Douwe Egberts, DTM, Duerr, EADS, EASM, Eberspaecher, Edeka, Edscha, Egemin, Egger, Eisenmann, Engeplan, Euraltech, Euro-Baltic, Excel Beef, F.EE, FAB, FAS, Fehr, Ferag, FFT Edag, Fibro, FKI, Flumroc, Ford, Franz Kaldewei, Fraunhofer IML, Friedrich Grohe, Friedrich Kurz, Frigoscandia, Fuji, Future, Gabs, Gaypasa, GEA Ecoflex, Geberit, Gebhardt, Gebr. Heinemann, Geico, General Motors, Genkinger-Hubtex, GFS, Gillette, Gilgen, GKN Aerospace, GM Europe, Gordon Food, Gorenje, Grammer, Gutweniger, Haefele, Haka Kunz, Hamberger, Hansa, Hansen, Hansgrohe, Heckert, Heidelberger Druckmaschinen, Herdoor, Hero, Herrmann + Hieber, Hirschi, Hoermann, Horstkemper, Huettenhoelscher, Hydro Aluminium, Hyundai, IBL, ICM, Ikea, Inoprojekt, Intertex, Jeld-Wen, John Deere, Jungheinrich, Kahla, KIA, Klingelberg, Knapp, Knauf, Knoll, Koenig & Bauer, Komatsu, Konecranes, Krka, Kroger, Kronos, Kronospan, Kronotex, Kuehne & Nagel, Kuka, Kvit, Lalesse, Lehnrieder, Leistritz, Liebherr, Loedige, LogSystems, Logtech, LTI, LTW, M. Kaendl, Magaziner, Magna Steyr, MAN, MAN Steyr, Mann + Hummel, Marti-Dytan, Mecalux, ME-JAN, Merck, Merckle, MFI, MGL Metro Gr, MLOG, MLR, Modine, Moll, Mondy, MPS, MT Aerospace, MTH, N K C, Naaraharju Oy, Neff, Neuburger Milchwerke, Nothelfer, OBO Bettermann, Osram, Pamag, Parker Hannifin, Paul Hartmann, Pfeifer, Pfizer, Pfeiderer, Pharmacia Kabi, phoenix, Plocher, Porsche, Prowell, PSA Peugeot Citroen, psb, Puissance, Puma, PWS, QS, R. Stahl, Remmert, Rewe, Reyher, Robatherm, Robert Bosch, Rolls-Royce, Rosenmuehle, Rosenthal, Rotem, Ruesta, Savoye, Saxenhuber, Schlafhorst, Schuler, Schwingshandl, Sebald, SEW, Shanghai General Motors, SHS, Siemag, Siemens, Siempelkamp Handling Systeme, SKF, Skoda Auto, SMC, SSI Schaefer, Staedtler, Stahlgruber, Still, Stoecklin, Stork PMT, Sturm, Suteng, Swisslog Accalon, Sysla, Systraplan, TBM, Teleafift, Telogs, Tente, Tetra Pak, TGW, Thoeni, Thyssen, ThyssenKrupp, Tiroler Roehren- und Metallwerke, TLS, TMS, Top Granit, Toyota, Trafoe-Foerderanlagen, Translift, Trapo, Ulma, Uni-Klinik Muenster, Unilever, Unitechnik Cieplik & Poppek, United Symbol, Vanderlande, Varena Lagerhaus, Varta, Vatech, Veitsch-Radex, Venjakob, Viastore, Villeroy & Boch, Volkswagen, Vollert, Volvo, Walgreens, Walmart, WashTec, Webb India Private Limited, Wegener & Stapel, Weissenburg, Weltbild, Westfalia, Willy Bogner, Winkel, Witron, Wittenbauer, WTT, Xella Baustoffe GmbH, Yamaha, Ytong

## WORLDWIDE – ALWAYS CLOSE TO YOU.

MIAS stands for “Maschinenbau, Industrieanlagen und Service” (Mechanical Engineering, Industrial Systems and Service). Behind the name is a typical success story in German mechanical engineering. The origins of the company go back to a traditional metalworking shop. In 1975, this grew into an engineering company for the development of warehouse systems. In 1985, MIAS was founded as a production company in its present form. Today, the MIAS group of companies has a workforce of about 300. Production sites are located in Germany, Hungary, the USA and China. Sales partners are also located in those countries as well as in Korea and Taiwan.

MIAS international.

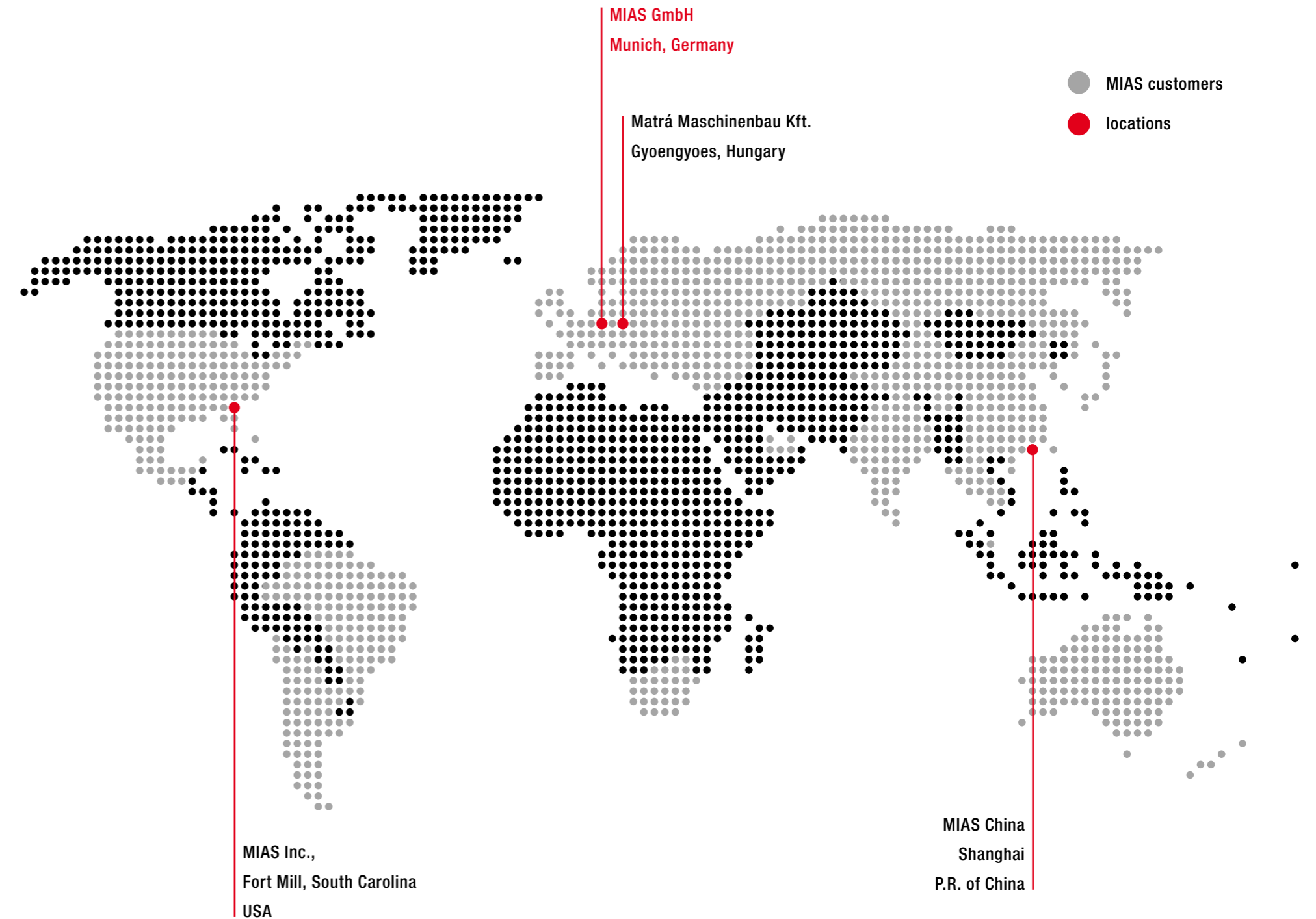



**[www.mias-group.com](http://www.mias-group.com)**

e-mail: [sales@mias-group.com](mailto:sales@mias-group.com)